

# PANEL ASSEMBLY B20 & C30

PANEL ASSEMBLY B20 164100-30100  
 PANEL ASSEMBLY B20 164100-30101  
 PANEL ASSEMBLY B20 164100-30102

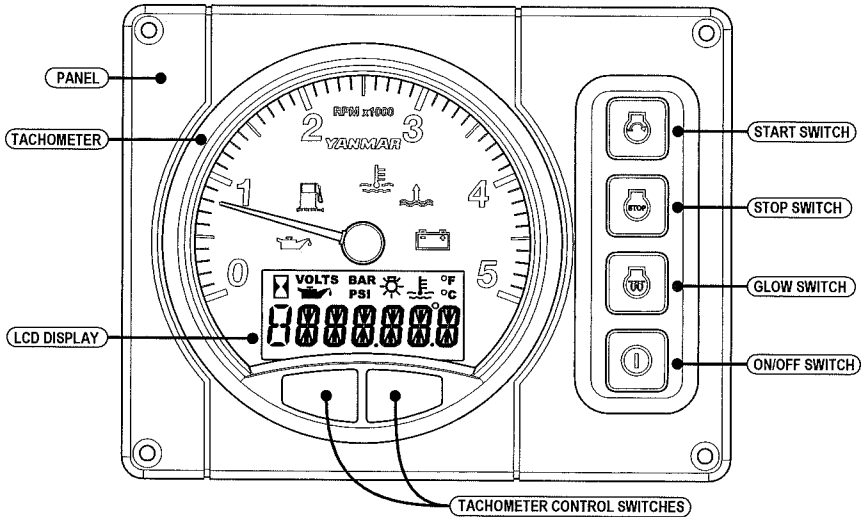



PANEL ASSEMBLY C30 164100-30300  
 PANEL KIT C30 164100-30210

## PANEL ASSEMBLY



### INDICATOR FUNCTION

When a sensor detects a problem during operation, the indicator inside the tachometer will light and an alarm will sound. Under normal operating conditions, the indicators are off.

	<p><b>Engine Oil Low Pressure Indicator and Alarm</b></p> <p>When the engine oil pressure falls below normal, the oil pressure sensor will send a signal to the indicator, causing it to light and the alarm to sound. Stop operation immediately to avoid damage to the engine. Check the oil level and troubleshoot the lubrication system.</p>
	<p><b>Water in Fuel Filter Indicator and Alarm (not on all engine models).</b></p> <p>When the water level in the fuel filter/water separator becomes too high, the indicator will light and the alarm will sound. Drain the water from the fuel filter/water separator.</p>
	<p><b>Coolant High Temperature Indicator and Alarm</b></p> <p>When coolant temperature reaches the maximum allowable temperature (95°C [203°F] or higher), the indicator will light and the alarm will sound. Continuing operation at temperatures exceeding the maximum limit will result in damage and seizure. Check the load and troubleshoot the cooling system.</p>
	<p><b>Water in Sail Drive Seal Indicator and Alarm</b></p> <p>When water is detected between the seals of the sail drive, the indicator will light and the alarm will sound.</p>
	<p><b>Battery Low Charge Indicator</b></p> <p>When the alternator output is too low, the indicator will light. When charging begins, the indicator will turn off.</p>

SWITCH FUNCTION	ACTION	BATTERY	ACCESSORY	GLOW RELAY	STARTER RELAY	STOP RELAY
	START ENGINE	MOMENTARY ON	●—————●	●—————●	●—————●	
	STOP ENGINE	MOMENTARY ON	●—————●			●—————●
	GLOW PLUGS	MOMENTARY ON	●—————●	●—————●		
	PANEL POWER	ON	●—————●			
	ON-OFF	OFF	●			

### WIRE HARNESS

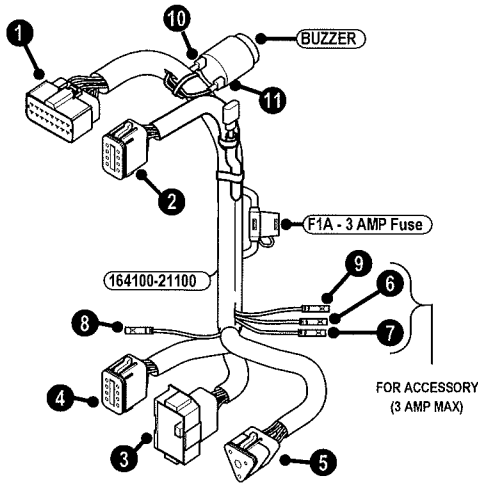

1	
1	BLACK BOAT GROUND
2	RED BATTERY
3	PURPLE ACCESSORY
6	BLUE WHITE FUEL TANK
7	DARK BLUE BACKLIGHTING IN
8	WHITE / BLACK WATER TEMP SENSOR
9	YELLOW / BLACK OIL PSI SENSOR
10	GREEN WATER IN FUEL
11	YELLOW / WHITE LOW PSI SWITCH
12	WHITE / BLUE HIGH TEMP SWITCH
13	YELLOW / GREEN SAIL DRIVE SEAL
14	BLUE / BLACK CHARGE
15	ORANGE TACH INPUT
16	TAN / BLUE BUZZER OUTPUT

2	
1	RED BATTERY
2	DARK BLUE BACKLIGHTING IN
3	PURPLE / WHITE PANEL POWER
4	WHITE START
5	WHITE / BROWN STOP
6	LIGHT BLUE GLOW
8	BLACK BOAT GROUND

3	
4	WHITE / BLACK WATER TEMP SENSOR
5	YELLOW / BLACK OIL PSI SENSOR
8	GREEN WATER IN FUEL

4	
1	YELLOW / WHITE LOW PSI SWITCH
2	WHITE / BLUE HIGH TEMP SWITCH
4	BLACK BOAT GROUND
5	YELLOW / GREEN SAIL DRIVE SEAL
6	ORANGE TACH INPUT
7	BLUE / BLACK CHARGE
8	PURPLE / WHITE PANEL POWER

5	
A	WHITE START
B	RED BATTERY
C	LIGHT BLUE GLOW

6	
PURPLE	ACCESSORY

7	
BLACK	BOAT GROUND

8	
WHITE / BROWN	STOP

9	
BLUE / WHITE	FUEL TANK

10	
1	TAN / BLUE BUZZER OUTPUT

11	
2	PURPLE / WHITE PANEL POWER

F1A - 3 AMP FUSE	
A	PURPLE / WHITE PANEL POWER
B	PURPLE ACCESSORY

## PANEL ASSEMBLY

### PANEL CUTOUT

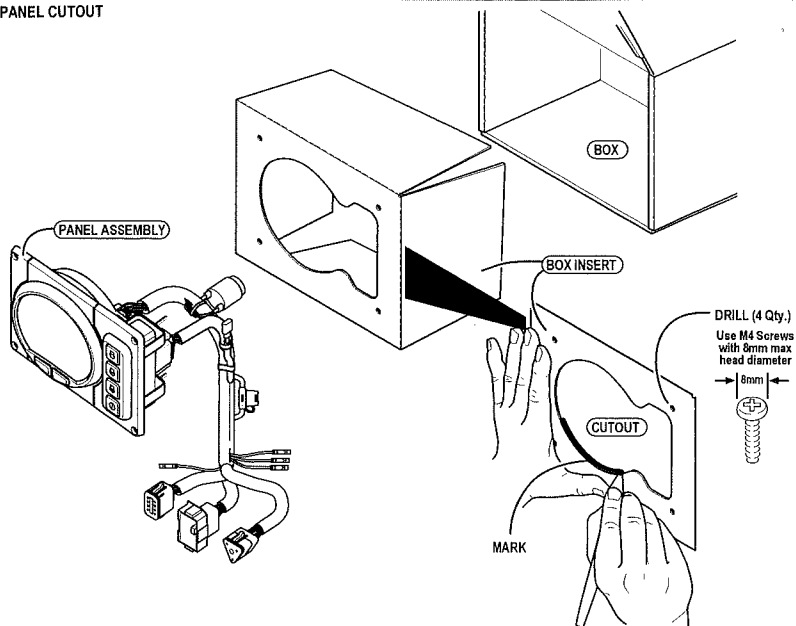

### OPTIONAL - B20 TO C30 PANEL CONVERSION

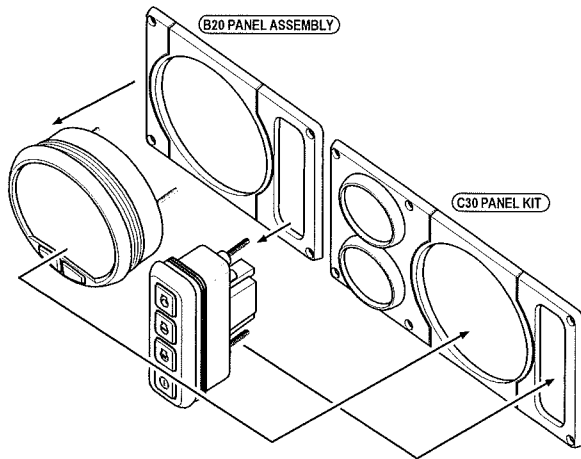

PANEL KIT C30 164100-30210

# PANEL ASSEMBLY

## OPTIONAL - VERTICAL PANEL INSTALLATION

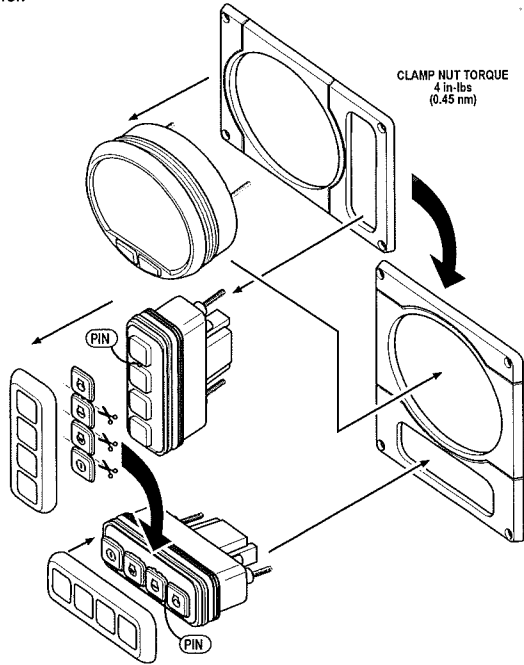
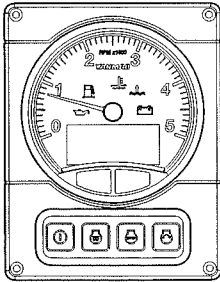

CLAMP NUT TORQUE  
4 in-lbs  
(0.45 nm)

## OPTIONAL - GAUGE INSTALLATION

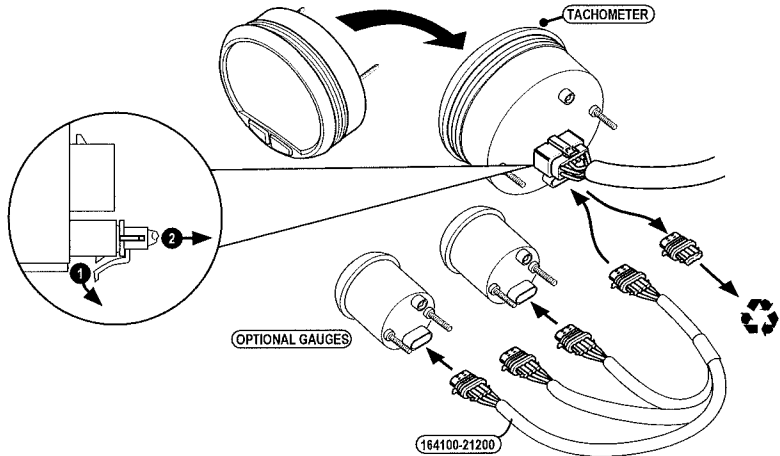

164100-21200

PANEL ASSEMBLY

OPTIONAL - CHROME BEZEL INSTALLATION

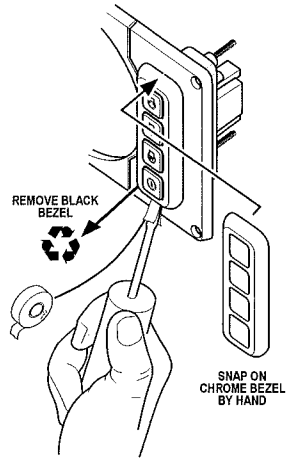
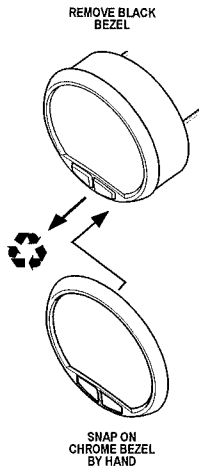
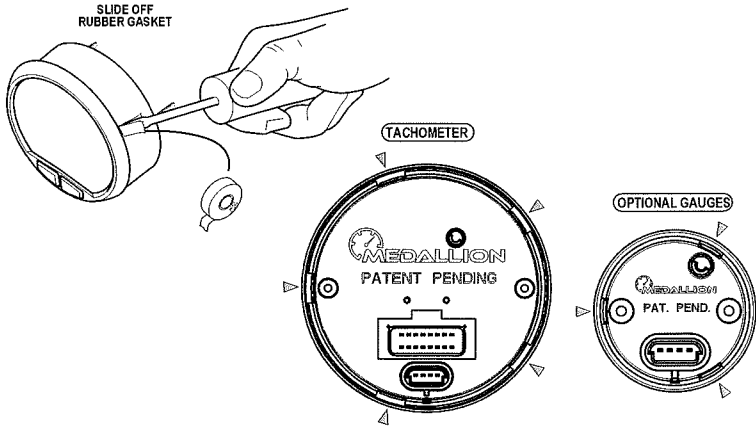

# LCD CONTROL

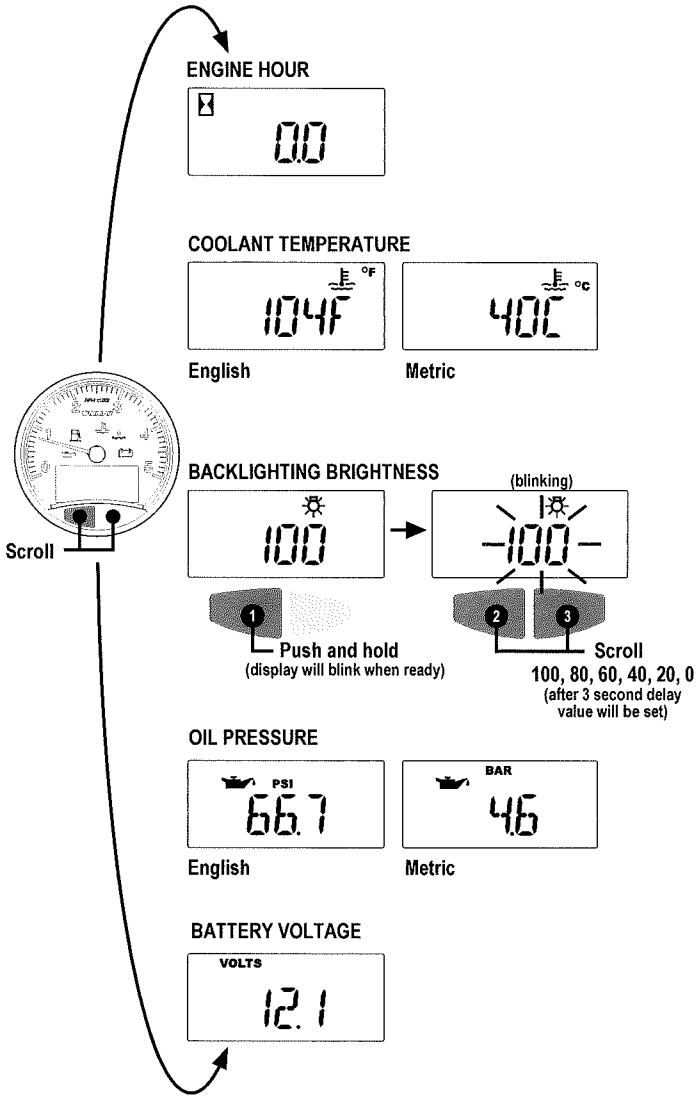

# SETUP SCREEN ACCESS AND CONTROL

Press and hold BOTH buttons until setup appears

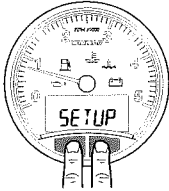

## SYSTEM UNITS

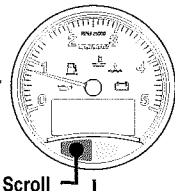
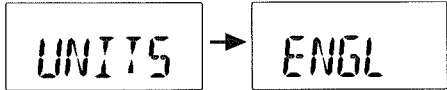

## ENGINE TYPE SELECT

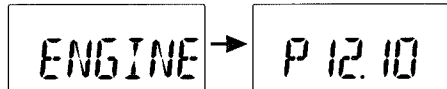

P 10.29, P 11.08, P 12.10, P 97, P 127

## EXIT SETUP

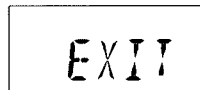

Return To Previous Page  
LCD Control

ENGINE MODEL	FACTORY DEFAULT	PULSE SETTING
1GM10		97
YMIJH5/JH4		10.29*
3YM27		11.08
YMIJH5/JH4 125A alt.	0	12.10
4JH3-DTE		127

\*164100-30100 & 164100-30101  
Factory Default P10.29

**YANMAR®**

YANMAR INSTALLATION INSTRUCTION  
6800-09514-01 REV C